

1999 - 2004 Land Rover Discovery 4.0/4.6L Rear Exit Options

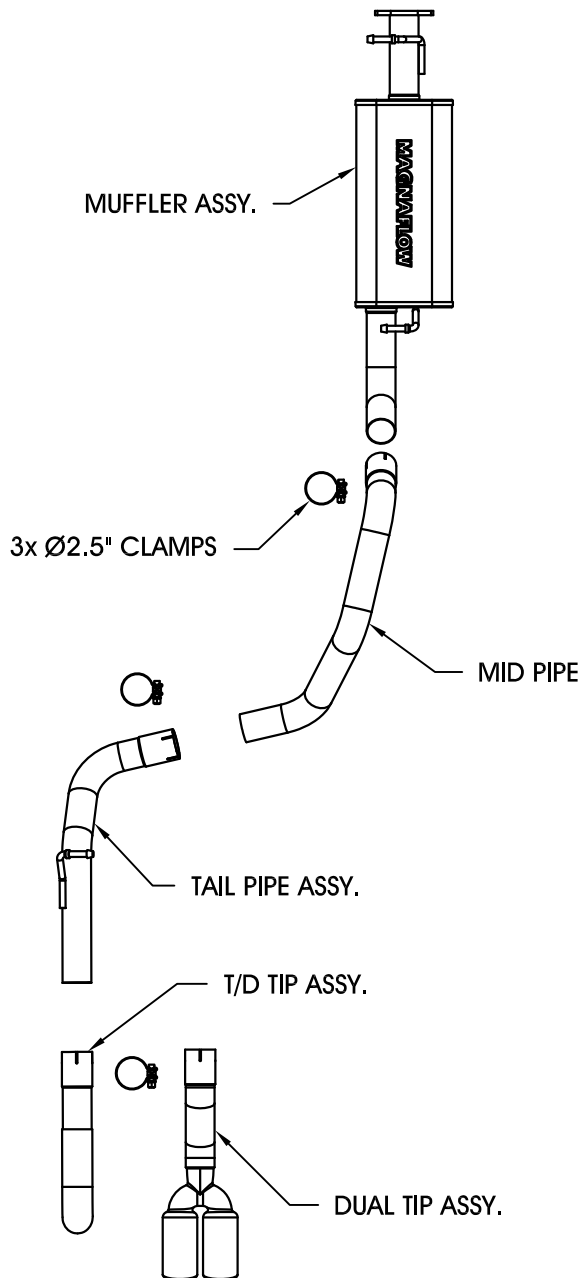

Warning: When working on, under, or around any vehicle exercise caution. Please allow the vehicle's exhaust system to cool before removal, as exhaust system temperatures may cause severe burns. If working without a lift, always consult vehicle manual for correct lifting specifications. Always wear safety glasses and ensure a safe work area. Serious injury or death could occur if safety measures are not followed.

Step 1: (Carefully read all instructions before installation) Disconnect the vehicle's battery before removal of the OEM exhaust. This will allow the computer to reset itself with the new system, and prevent electrical accidents.

Step 2: Unbolt the OEM exhaust from the catalytic converter outlet flange. Disengage OEM hangers from the rubber insulators. Removal may require the OEM system to be cut. Carefully remove the system making sure to retain all mounting hardware and rubber insulators as they will be needed to install your new MAGNAFLOW system.

Step 3: Begin installing your new system by bolting the inlet flange of the muffler assembly to the catalytic converter flange using the existing nuts and bolts. Insert the mounting hangers into the rubber insulators. Next, slip the Mid-Pipe inlet over the muffler assembly outlet. Slip Tail Pipe assembly over the Mid-Pipe outlet and insert hanger into the rubber insulator. Choose either the Dual or Turn Down tip option. Secure using the supplied clamps.

Step 3: With all components mounted loosely, adjust the system for overall aesthetics and clearance of frame & bodywork. (MAGNAFLOW recommends at least 1/2" of clearance between the exhaust system and any body panels to prevent heat-related body damage or fire.)

Step 4: Once a final position has been chosen for the new system, evenly tighten all fasteners from front to rear. The supplied band clamps must be VERY tight to properly align the pipes and prevent leaks (Approximately 40ft-lbs). U-bolt clamps should be tightened to approximately 30-35ft-lbs. Inspect all fasteners after 25-50 miles of operation and retighten if necessary.

Technical support: 1-800-959-9226 ext. 4500

*MAGNAFLOW Performance Exhaust recommends professional installation on all their products